

Digital Banking 2.0

Jefferies India Tech Summit

November 2021



India's **Best** Digital Bank



National E-Summit & Awards

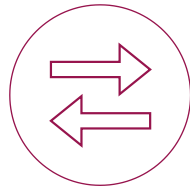

15%

Market share in UPI transactions¹

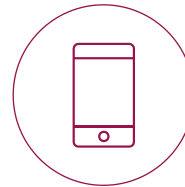

13%

Market share in Mobile transactions¹



















4.6

App ratings (Apple store)

1. In terms of volumes for Q2FY22

Digital Banking – Axis Bank’s “silent revolution”

 <p>D2C products</p>	<p>~77% </p> <p>Credit cards issued**</p>	<p>76% </p> <p>Digitally active customers (Q2FY22)</p>	<p>71% </p> <p>New SA acquisition* (Q2FY22)</p>	<p>67% </p> <p>Fixed deposits opened (H1FY22)</p>	<p>55% </p> <p>PL disbursed**</p>	<p>48% </p> <p>New MF SIP sales (H1FY22)</p>	<p>4.6 </p> <p>Mobile App ratings</p>
 <p>Transformation</p>	<p>250+ </p> <p>Services on digital channels</p>	<p>15% </p> <p>Market share in UPI (Q2FY22)#</p>	<p>13% </p> <p>Market share in mobile (Q2FY22)#</p>	<p>91%</p> <p>Digital transactions^^</p>	<p>95,000+ </p> <p>Staff on BYOD~</p>	<p>~980</p> <p>Automated processes (IA)</p>	<p>300+</p> <p>Employee tool Journeys</p>
 <p>Capabilities</p>	<p>~1000</p> <p>People dedicated to digital agenda</p>	<p>~250 </p> <p>In-house development team</p>	<p>~77% </p> <p>New hires from non-banking backgrounds</p>	<p>PB</p> <p>Scale big data Hadoop clusters</p>	<p>120%</p> <p>Lift of bank credit model GINI scores over bureau</p>	<p>~50 </p> <p>Apps on Cloud</p>	<p>Agile</p> <p>Enabled teams with CI/CD, micro-services architecture</p>



<p>140 Mn</p> <p>KTB¹ Customer base</p>	<p>~5 Mn</p> <p>Non Axis Bank customers using Axis Mobile & Axis Pay apps</p>	<p>23%</p> <p>Contribution of KTB channels to overall sourcing of Cards (in H1FY22)</p>
---	--	--

* Tablet based account opening process for Q2FY22

^^Based on all financial transactions by individual customers in Q2FY22 ** through phygital and digital mode in H1FY22 # by volume ¹Known to Bank



Top 3

Digital leadership and technology driven transformation are key pillars of our GPS strategy

-  **Strengthen the organizational core and quality of our balance sheet significantly**
-  **Invest in technology capabilities to deliver on our Transformation plans**
-  **Act with relentless focus on making Axis digital**
-  **Build granularity across all our business segments to drive sustainable growth**
-  **Deliver strong operating performance with improvement in return metrics**
-  **Create significant value among our key subsidiaries**

Our digital strategy is aligned with our GPS strategy

A

Reimagine Customer Proposition



Digital-first products embedding design thinking



End-to-end simplification of customer journeys



Banking services **integrated across partner ecosystems**



Omnichannel experience to differentiate customer experience and **hyper personalization**

**B**

Transform the Core



Ops excellence & institutionalization of data & tech enabled operating rhythm



Twin-engine approach to build digital stack and **modernize the core**



Modular, resilient technology with **Cloud first** architecture



Proprietary in-house capabilities for accelerated design and go-to-market



Next gen **cyber security capabilities**

C

Build Future-ready Capabilities



Data architecture 3.0; moving beyond analytical models to **data engineering**



Integrating **alternate, unconventional data** for **risk-moderated growth**



Digital workforce for digital consumers







Creating a **cutting edge, future ready workspace 2.0**

The OPEN philosophy underpins everything we do

O 0-based redesign ; customer centric, design led and 0-operations	 Playbook for agile, customer centric design for all teams to collaboratively change the Bank
P Proprietary in-house capabilities	 Building in-house capabilities on different elements such as design, experience centre, agile and AI centres-of-excellence among others
E Ecosystems capable ; built for all Axis and partner channels	 Dedicated Partnerships team and market beating API strategy to deliver the open ecosystems proposition
N Numbers, Numbers, Numbers: Impact led and metrics driven	 Organization-wide thrust on identification and tracking of outcomes as well as input metrics to drive Impact

- Initiatives across **all customer segments** (retail, commercial, and corporate) and **employees**
- **Impact** targeted across different stages of the **customer lifecycle** (acquisition, cross-sell and up-sell, lifecycle management and risk management)

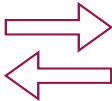
We are working on 30+ initiatives to execute our digital strategy

	Acquisition	Cross sell / Up sell	Lifecycle management	Risk management
Retail liabilities 	LEAP: Digital journey for CASA opening Partnerships for SA acquisition NTB acquisition for FDs	Pre-approved and e2e digital journeys for Bank and third party products: MFs, Digital Gold, Forex, PFM, credit cards, PL	Archetype based personalized automated journeys for priority segment Lifecycle management of all products on mobile app Olive: Convert to EMI, CLI, card upgrade, instant loan Card partnerships: Flipkart Card console	Managing Ops risk: Early alignment with ctrl functions, fast track processes; and Tech risk: Controlled and automated testing : Alternate data for customized credit and fraud models Digital Collections initiatives: Recalibrated for the Test and learn post COVID normal
Retail assets 	Maximus: OD FD, Auto loans, Personal loans Buy now Pay later, Home loan Acquisition partnerships: GPay, Freecharge and many more expected	Outward remittance on mobile app Buy now, Pay Later		
Payments & Cards 	Partnerships with Flipkart, Vistara Maximus: Axis led acquisition End to End Digital Issuance of Cards	Olive: Convert to EMI, CLI, card upgrade, instant loan		
CBG 	Digital CA acquisition Digital Business Loan Lending on informational collateral: GST, POS Sankalp: Technology led sales effectiveness	Sankalp: Technology led sales effectiveness and credit process transformation		
Corporate 	Project Neo: Journey re-imagination, nudges on the platform for product recommendations, enhanced API proposition and partnerships with Neobanks, aggregators etc. and SCF platform revamp GCG initiatives: e-NAM, e-freight, e-tendering & e-auction, GeM procurement			
Internal employees 	Siddhi: Analytics based tool for sales and managerial effectiveness to enable meaningful customer conversations Digitally assisted journeys for sourcing via tab: Acquisition, cross-sell and upsell (on-KYC), enabled by BYOD Sankalp: Reimagined loan origination and credit process simplification along with tools data and digital for sales force effectiveness		Digitally assisted journeys to support collections: App that enables geo-tagging, route planning, prioritized lists	

Each of these journeys is further transformed based on the OPEN philosophy

Our digital strategy is aligned with our GPS strategy

A

Reimagine Customer Proposition



Digital-first products embedding design thinking



End-to-end simplification of customer journeys



Banking services **integrated across partner ecosystems**



Omnichannel experience to differentiate customer experience & **hyper personalization**

**B**

Transform the Core



Ops excellence & institutionalization of data & tech enabled operating rhythm



Twin-engine approach to build digital stack and **modernize the core**



Modular, resilient technology with **cloud first** architecture



Proprietary in-house capabilities for accelerated design and go-to-market



Next gen cyber security capabilities

C

Build Future-ready Capabilities



Data architecture 3.0; moving beyond analytical models to **data engineering**



Integrating **alternate, unconventional data** for **risk-moderated growth**











Digital workforce for digital consumers



Creating a **cutting edge, future ready workspace 2.0**



Digital is an important customer acquisition engine for the Bank, which continues to achieve scale

	Product	Where we were (Dec '20)	Latest update (Sep' 21)	
Deposits 	Video KYC enabled Savings Accounts (non salaried)*	10%	20% ²	
	Video KYC enabled Savings Accounts (salaried)	--	8% ²	
	Fixed Deposits (for existing and new customers)	71% ¹	67% ³	
Assets 	Personal Loans	54% ¹	55% ⁴	
	Credit card	78% ¹	77% ⁴	
	Credit Card – EMI conversion	29%	71% ³	

¹ Q3FY21 ² Q2FY22 ³ H1FY22 ⁴ through phygital and digital mode in H1FY22

*excluding NRIs, Government and trust accounts













Digital is an important customer acquisition engine for the Bank, which continues to achieve scale

	Product	Where we were* (Dec '20)	Latest update* (Sep '21)	
Investments 	Mutual Funds (new SIP sales)	36% ¹	48% ²	
	Public Provident Fund	80%	95%	







We continue to introduce and scale new products driven by our *zero-based redesign philosophy*

Detailed further

Our product portfolio

Deposits		Investments & Insurance		Loans & Cards	
					
Saving Accounts	Current Accounts	Mutual Funds	General Insurance	Personal loan	Credit cards
					
Fixed Deposit	PPF	Forex card	Life Insurance	GST based business loans	Auto loans

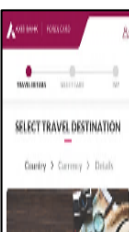
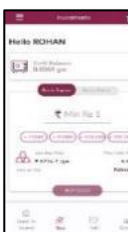
New launches

			
Buy Now Paylater	GrabDeals	Cards lifecycle	Auto loan
			
O/W Remittance	Digital Gold	Insurance 2.0	ODFD

0-operations based redesigned journey with customer at the centre, minimum to no data entry and all checks done by machines with automated underwriting

Buy Now Pay Later on Freecharge

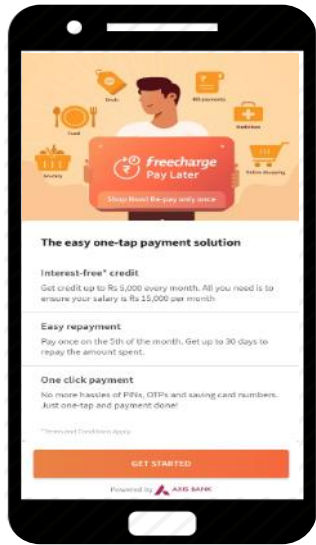

Customer clicks on paylater banner and can view details

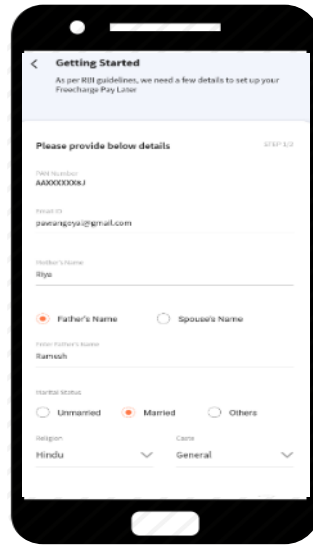

Customer provides basic personal details

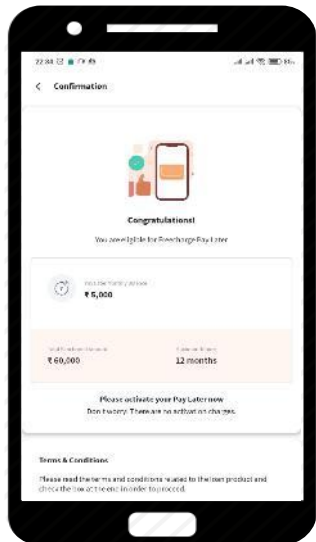

Customer is shown offer and Terms and conditions

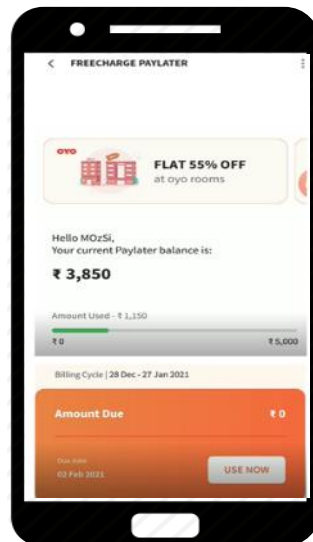

Customer can view remaining and utilised limit at anytime

O

Insta onboarding, decisioning & activation – all in **3 steps in less than 3 minutes**

Also available for new-to-Bank customers

P

Launched on the **Bank's proprietary Jarvis loan management platform**

E

Built in partnership with Freecharge – can be plugged in other platforms too

N

16x QOQ growth in customers acquired and **20x** QOQ growth in transactions in Q2FY22

Buy Now Pay Later on Freecharge | Developed on 'Jarvis': our in-house developed, cloud native, API oriented lending platform

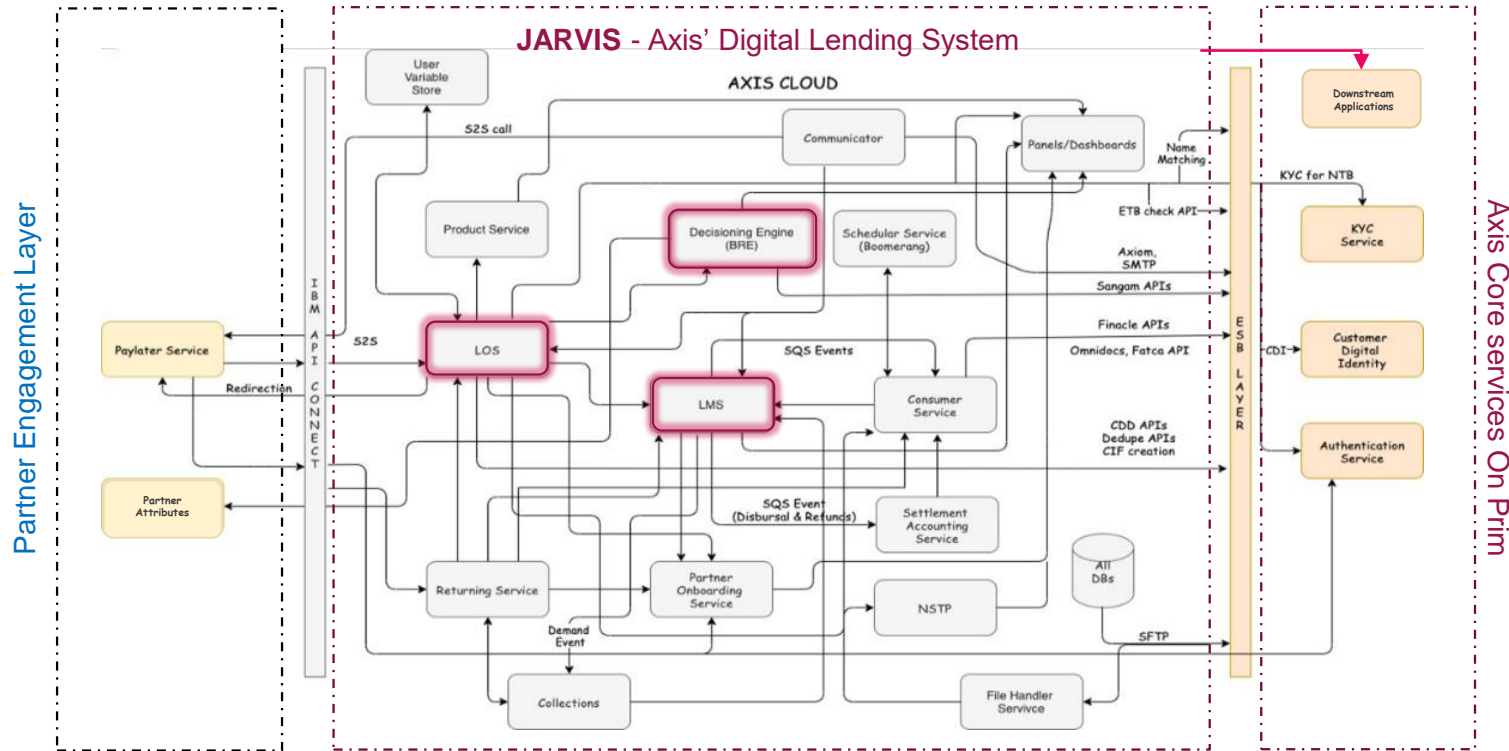

New-age Loan Management System

- Supports small ticket, small tenor, limit/loan, multiple interest rate/fee structures
- 100% digital journeys – No manual intervention

Custom built, Cloud native, API oriented

- Built, managed, run inhouse
- Built for partners
- Modular, loosely coupled
- 100% on AWS

Scalable and Customizable

- CI/CD in place with best practice AWS tools (externally recognized)
- Custom built BRE – Runs multiple policies
- All forms of KYC supported

Integrated with downstream systems

- Collection & recovery
- Statutory & regulatory reporting
- Financial reporting

Leap | Digital Savings Account onboarding

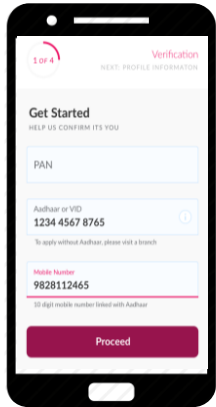

After choosing from 5 SA variants, Customer shares Aadhaar, PAN and mob number for EKYC

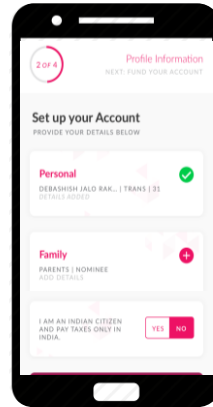

Customer provides personal, family and address details

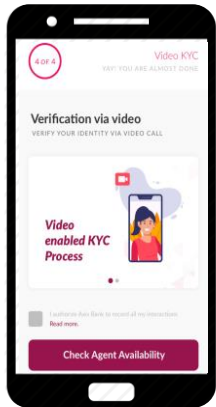

After successfully initiating VCIP, customer makes payment for Initial Funding

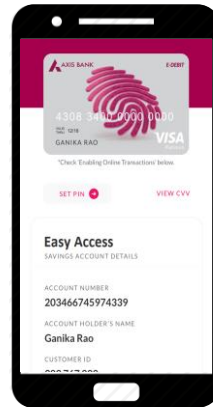

Account and Virtual Debit Card details are displayed and shared on email



O

Mobile first, customer driven design with **~90% of savings accounts** getting **activated within 24 hours**
Higher flexibility on schemes vs. peers

P

Axis Bank's **first application** to be **hosted completely on the Cloud**

E

Designed to scale with **micro-services** at each step that cater to all other VCIP applications as well

N

~20% of Retail SA (excluding salary) acquired digitally with better true rate

Leap Digital Savings Account | Impact

Operational impact, Indexed

Physical documents required

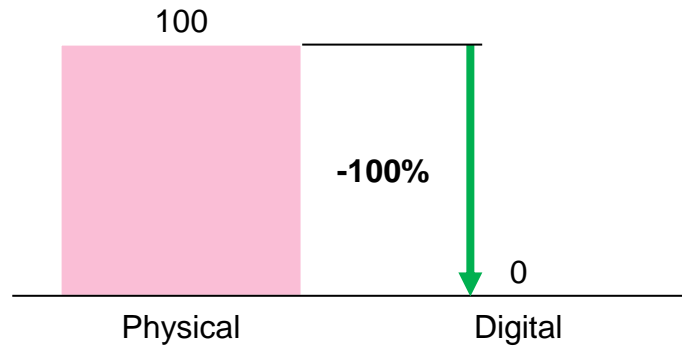

NTRF*

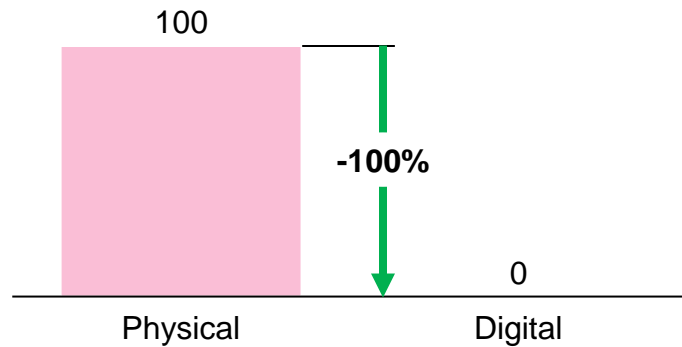

Financial impact, Indexed

Cost of acquisition

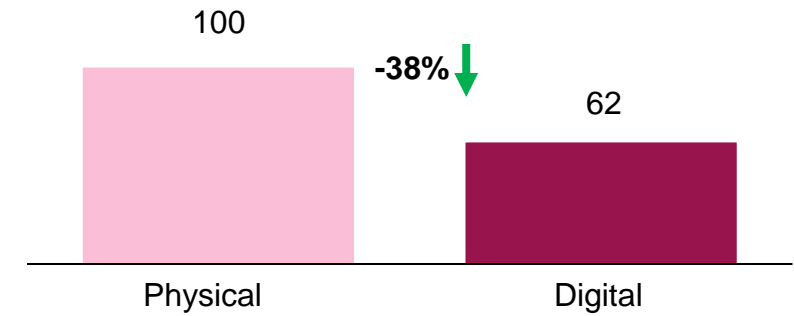

True rate

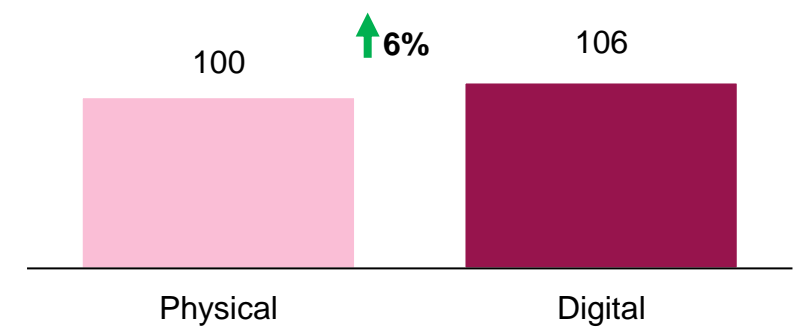

Grabdeals e-commerce marketplace | Festive season helps to achieve blitz scale and gain significant customer traction

About Grab Deals Festive season

27 Days Up to **10%** cashback

5 Partners

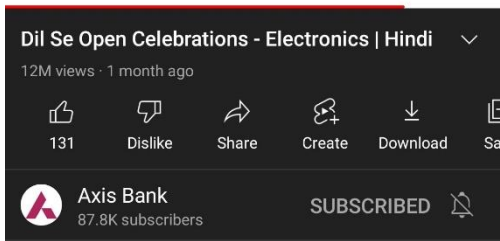
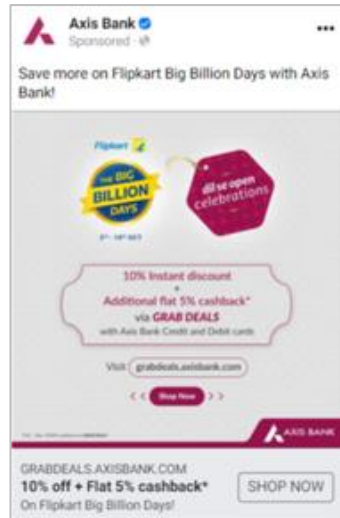

17 Mn views on YouTube

O Simple 3-step process to avail cash back on Grab Deals: *Browse* → *Authenticate* → *Shop*
Integrated with **WhatsApp channel**

P Seamless CX due to close integration with Axis mobile and internet banking
Planned integration with **Axis's UPI platform**

E Expandable, Dynamic Cloud based solution to enable rapid partnerships
40+ brands available on the platform

N **30x** growth* in **Gross Merchandise Value** over last year exit numbers

* Monthly GMV in Oct'21 over Mar'21

We are adopting a combination of approaches for the digital ecosystem

Build our own capabilities, partner with FinTechs where there is complementarity and invest in areas that have adjacencies



We are seeing improved traction in cards acquisition aided by KTB partnerships

New Credit Cards acquisition (indexed to 100)

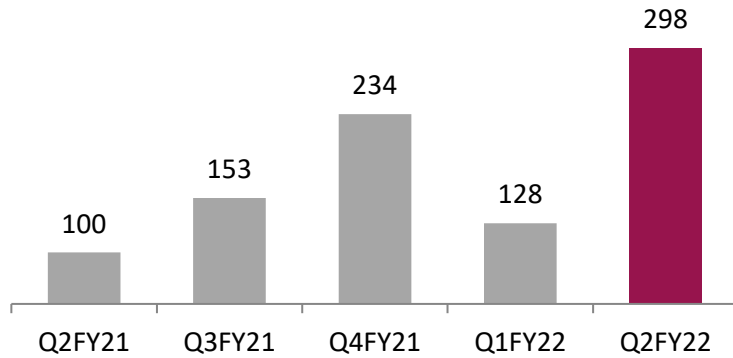

Share of KTB^ sourcing

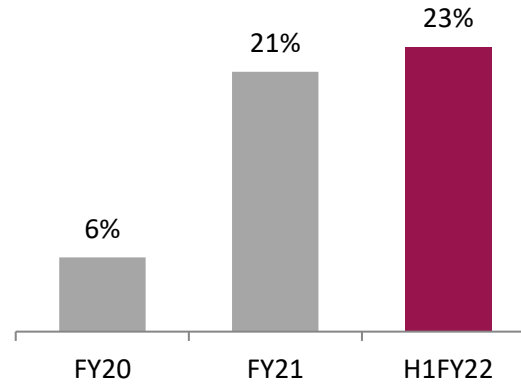

^ Known to Bank

Credit Cards in force (mn)

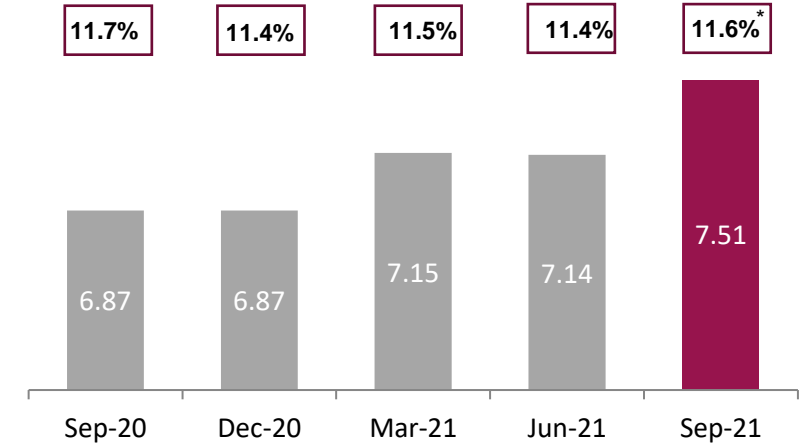

* Note: Figures in boxes represent market share

Premium Cards



Co-branded Cards



Flipkart Axis Bank Credit Card

One of the fastest growing co-brand portfolio with 1.36 million CIF in 26 months since its launch

Featured Cards



Axis Bank ACE Credit Card

Flipkart Axis Bank Credit card | Acquisition journey

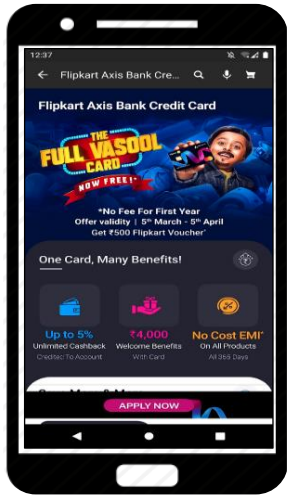

Customer clicks on Flipkart Axis Bank Credit card banner and can view details

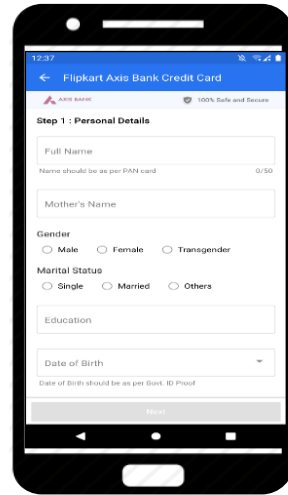

Customer fills up the form and submits the application

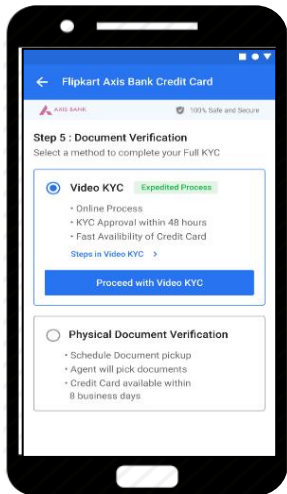

Approved customers complete KYC and income verification via digital or physical channels

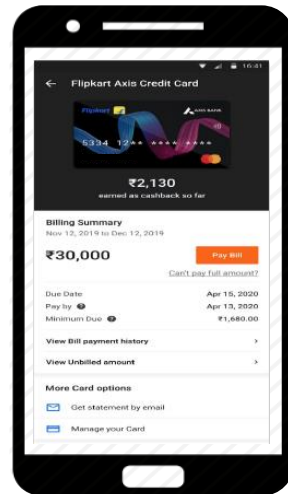

Card is generated and the customer can view and manage card features via Flipkart console

O

Digital acquisition, fulfilment & servicing via partner platforms
Video KYC and Digitization of Income Documents to digitize application journey – *unique to Axis Bank*
10+ DIY card management features live on Flipkart



P

API based digital journeys using Bank's onboarding and customer management platforms to deliver seamless experience

E

Built in partnership with Flipkart and is being expanded across other partnerships

N

1.36 Mn CIF of the Flipkart Axis Bank Card (as of Sept'21)

Flipkart Axis Bank Credit card | Impact

Customer impact, Indexed

30 day Early activation

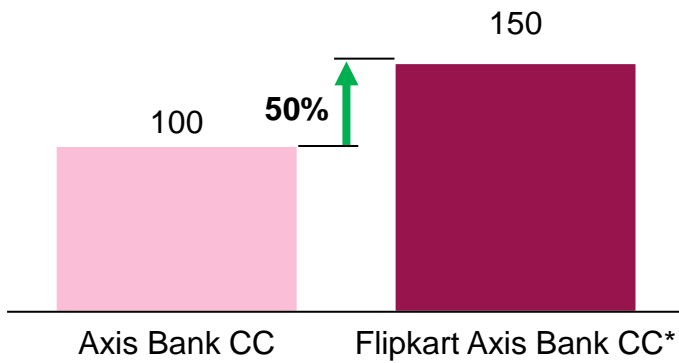

Monthly activity

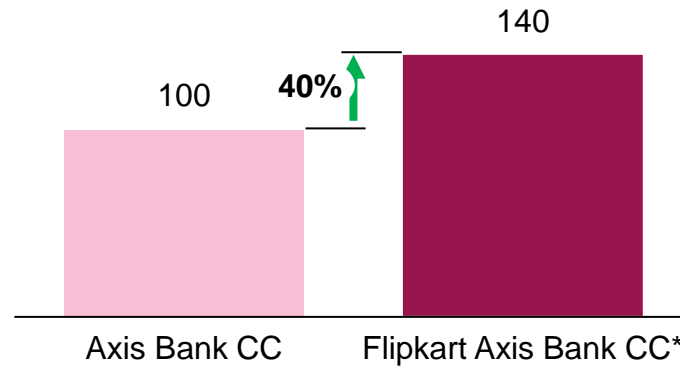

Financial impact, Indexed

Spends/open

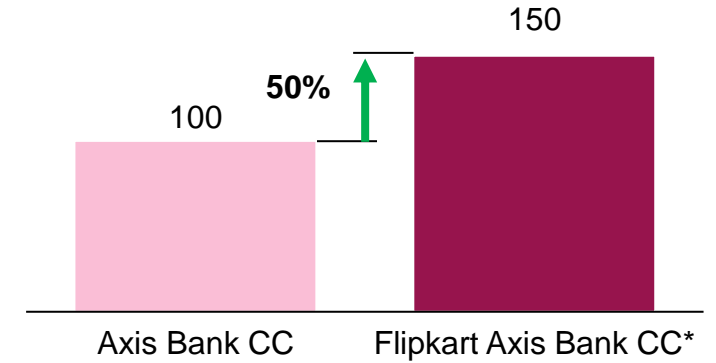

* Flipkart Axis Bank CC are the cards acquired via Flipkart platform
Note: Based on the aggregate data for the period Jul-21 to Sep-21

Our Mobile Banking volumes continue to grow



Axis Mobile is amongst the highest ranked Banking app on Apple Store (rating of 4.6) & Google Play Store (4.5) and offers 250+ DIY services

Axis Bank Mobile Banking Volumes (in Mn)

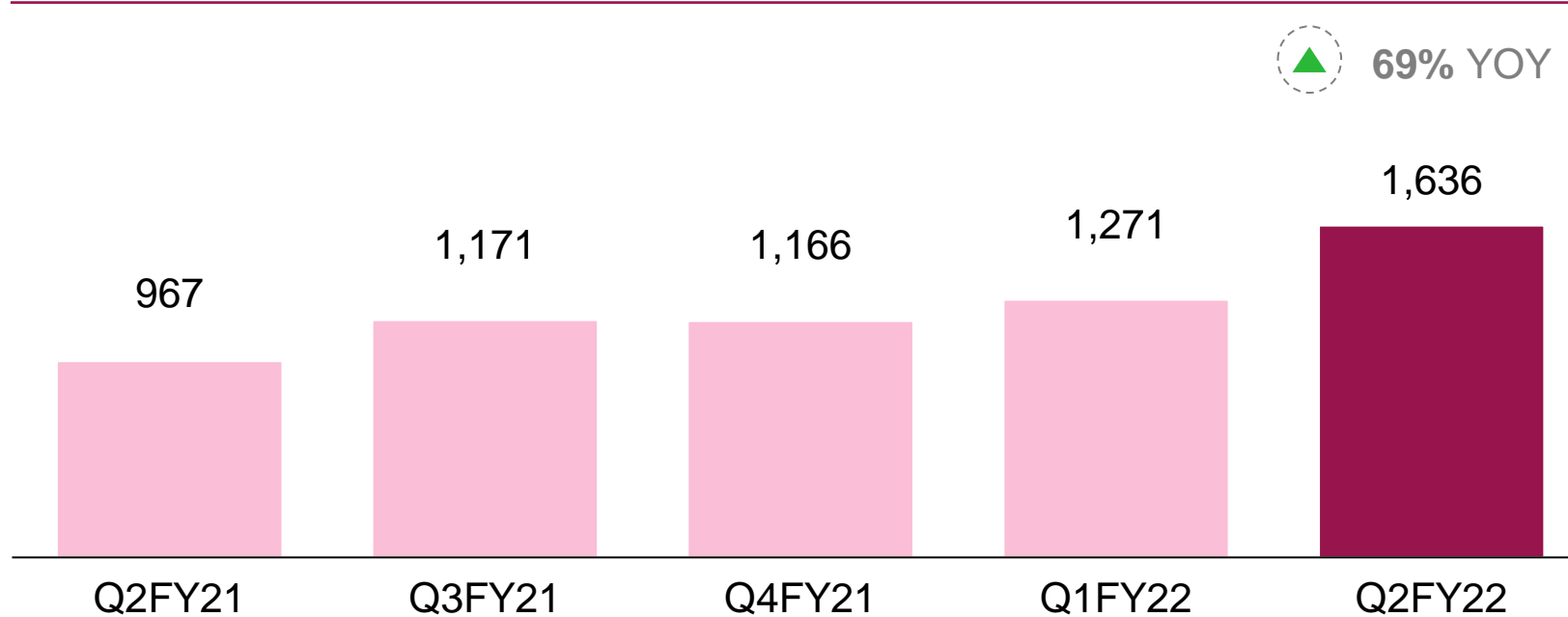

~5 Mn non-Axis Bank customers using Axis Mobile & Axis Pay apps



Mobile Banking logins at ~15 times Internet banking logins



Axis Aha! Chatbot answered 5.84 Mn messages in Q2FY22



55% of Mobile Banking customers bank only on Mobile App

WhatsApp Banking emerging as a significant channel

Account Related

- Get your Account Balance
- Generate Account/Mini Statement
- Order Cheque Book

Credit Card Related

- Get your Outstanding Amount, Available Credit Limit
- Summary of Credit Card, Bill Payment details
- Block your Credit Card and many more to come.

What else you can do?

- Ask us Anything
- Get Pre-Approved Personal Loans in WhatsApp
- Apply for our Banking Products
- Locate Axis Bank Branches/ATM and many more to come.

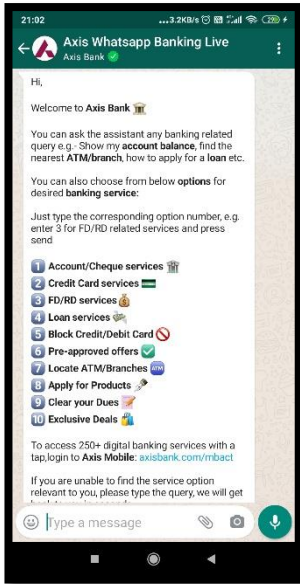

Comprehensive & simple menu option

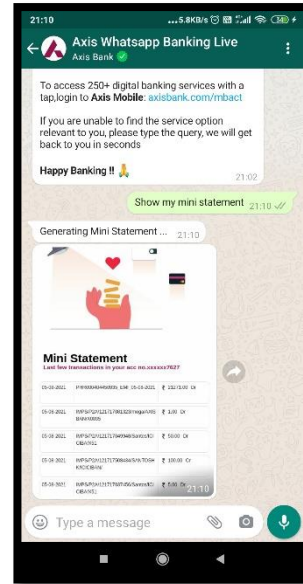

Rich cards to show better & simplified view

O

Insta Opt-In, real-time fulfilment of request on WhatsApp with **24x7 availability**
AI enabled Axis Aha integration to answer all FAQs

P

Hosted and managed on Axis Bank private cloud

E

Seamlessly integrated with WhatsApp for an almost native experience in customer's chat window

N

2mn+ customers onboarded

6mn+ customer interactions over last 10 months



10 months of successfully delivering banking services through WhatsApp



15

Total Services Live



2.3 Mn+

Unique Customer Opt-ins



6.2 Mn+

Customer Interactions



Account Level Enquiry

3.3 Mn+



Credit Card Enquiry

1.5 Mn+



FAQs Answered (via Aha!)

4.2 Mn+

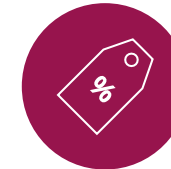

Pre Approved Offers

0.6 Mn+



Axis Locations

1.2 Lac+

Requests

0.9 Mn+

0.7 Mn+

1.4 Mn+

0.3 Mn+

64k+

Customers

Setting up best-in-class personalization engine to deliver distinctive customer experience...

Creating Digital DNA elements for more than **26 Mn** customers



CUSTOMER

- What is the current life stage of a customer? – *Married with kids*
- What does a customer do? – *Self Employed - Doctor*
- How much does the customer earn? – *143K per month*
- Where does the customer live? – *Tier 2 city*

Leverage DNA variables to understand the customer better & engage with them accordingly

Illustrative – Customer joined the bank as a student in 2013 and today as per the data, we can call her life stage to be **“Married with kids”**

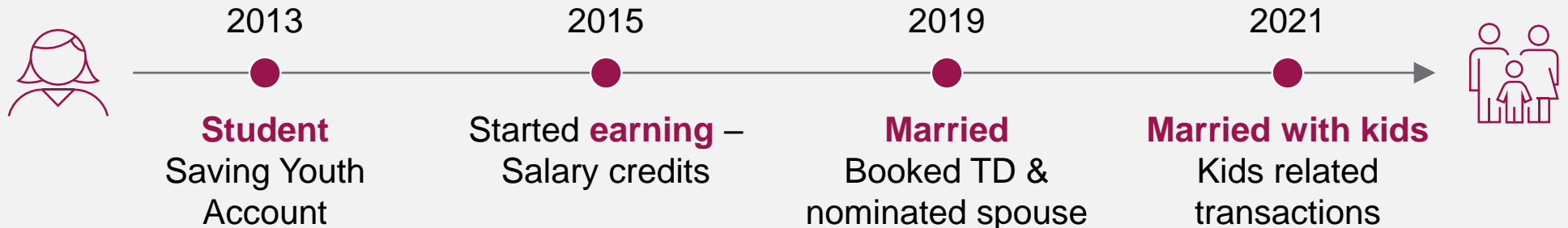

100+ nudges developed & deployed via custom cloud native serving layer

Leveraging situational triggers to craft a multistep curricula for ETB ...

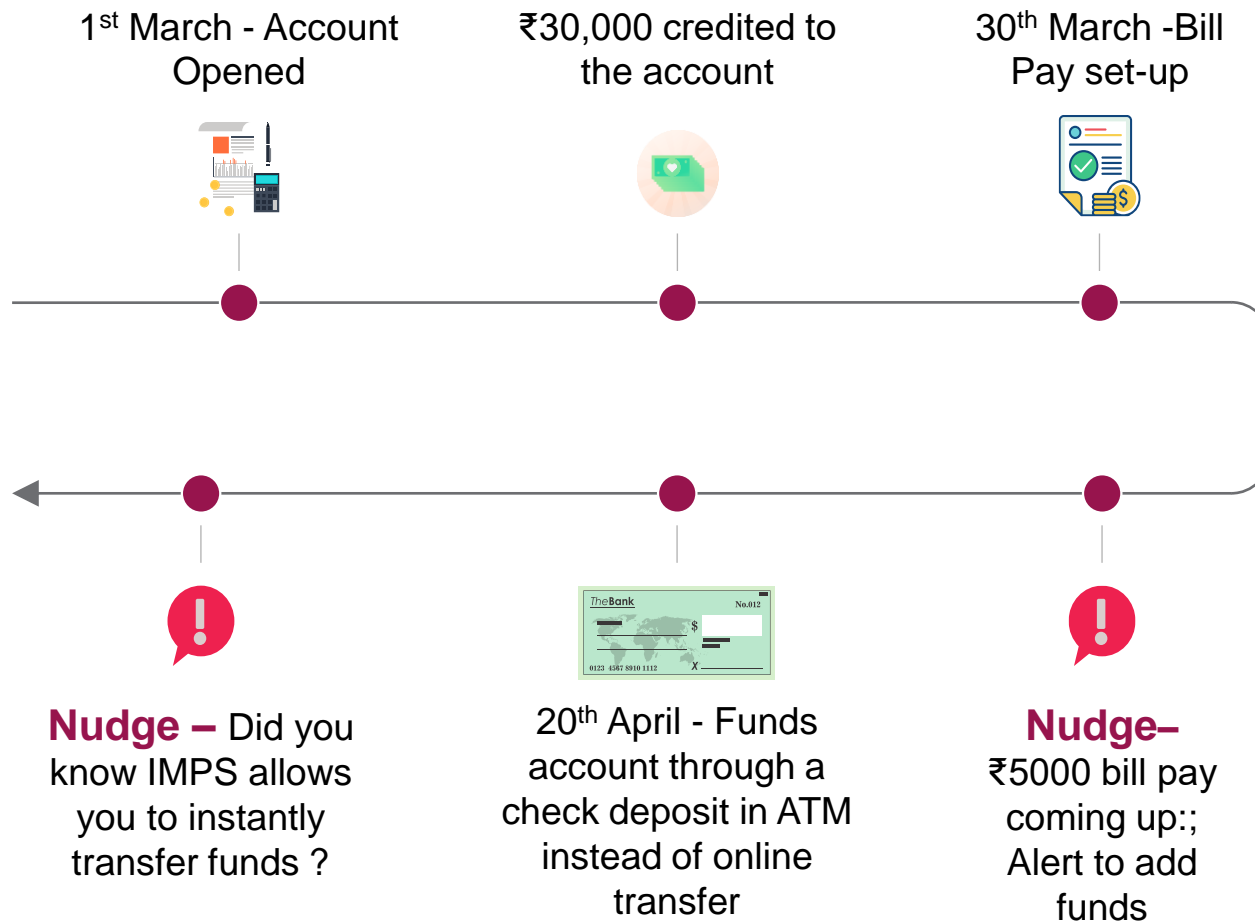

... & NTB to develop depth in engagement

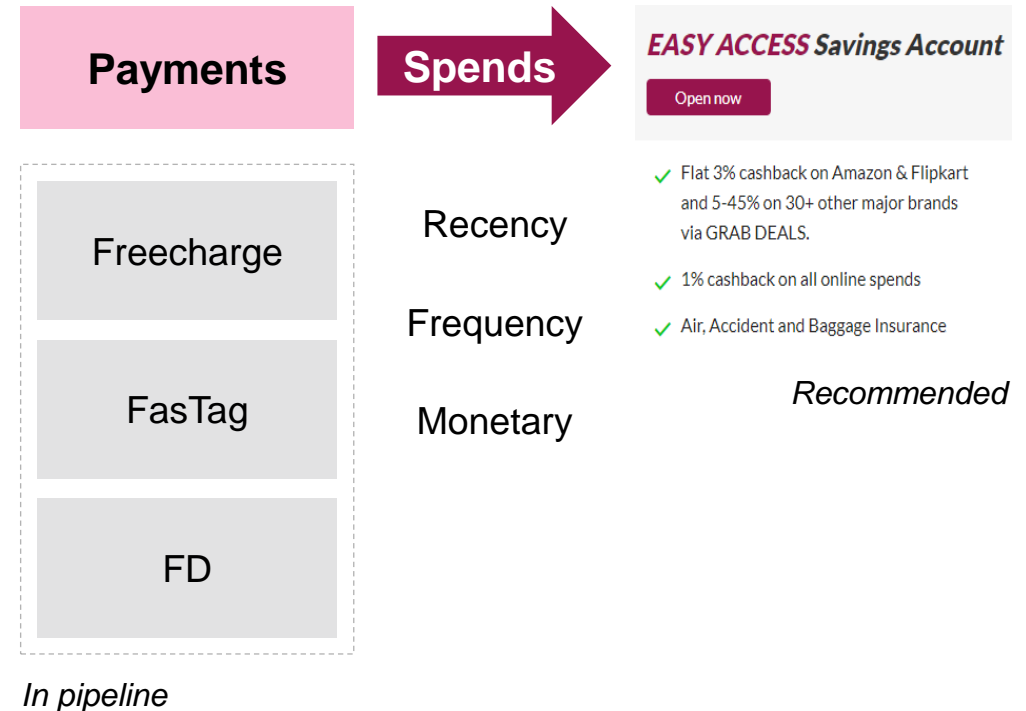

Our digital strategy is aligned with our GPS strategy

A

Reimagine Customer Proposition



Digital-first products embedding design thinking



End-to-end simplification of customer journeys



Banking services **integrated across partner ecosystems**



Omnichannel experience to differentiate customer experience & hyper personalization

**B**

Transform the Core



Ops excellence & institutionalization of data & tech enabled operating rhythm



Twin-engine approach to build digital stack and **modernize the core**



Modular, resilient technology with **cloud first** architecture



Proprietary in-house capabilities for accelerated design and go-to-market



Next gen **cyber security capabilities**

C

Build Future-ready Capabilities



Data architecture 3.0; moving beyond analytical models to **data engineering**



Integrating **alternate, unconventional data** for risk-moderated growth



Digital workforce for digital consumers



Creating a **cutting edge, future ready workspace 2.0**

Branch of the Future | Transform the way Axis Bank engages with and serves its customers

Re-engineer key service requests to **release frontline capacity** from servicing and enable **focus on relationship building** & sales

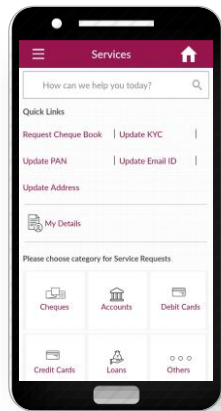

Customer clicks on **Update Address**

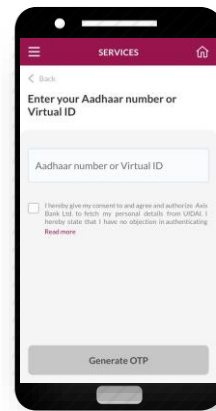

Enters Aadhaar number and **OTP** for authentication

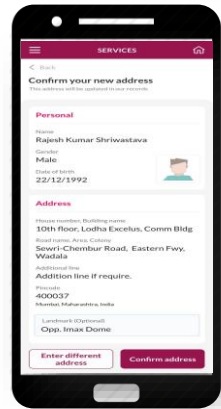

Confirms the details fetched from **UIDAI**

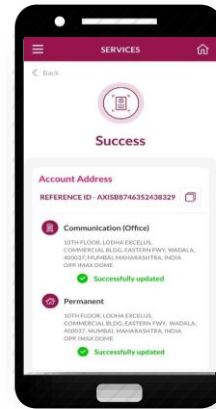

Request is processed and customer is shown a **Success screen**

50+ Initiatives identified and underway

O

250+ services available digitally – amongst the highest in industry

Only Bank to provide OCR based document classification, Instant demographics updation through Aadhaar

P

A proprietary **cloud** solution that's **integrated with all core bank systems** for real time processing of service requests

E

Easy to integrate with other non-digital channels to provide an **omni-channel experience** to customers

N

92%+ digital requests processed real time via straight through processing

~20% time saving for tellers and BROs targeted

Services accounting for
~65%
of request volumes in
branches are now
digitally available

**Aggregated
metrics**

92%+
STP rate

<1%
NFTR rate

60%*
Digital adoption

Updation of PAN service request illustration

STP increased by

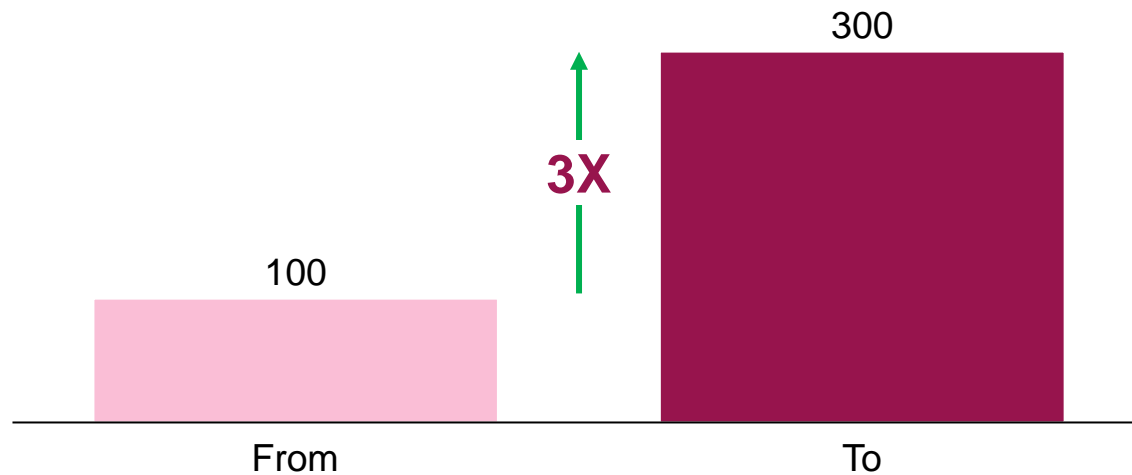

NFTR reduced by

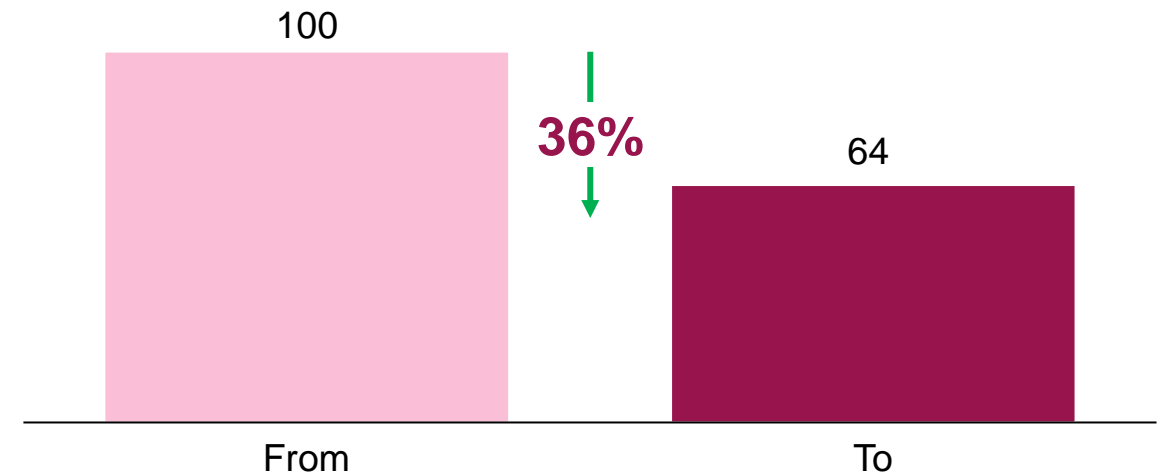

*Digital adoption is basis requests processed through digital and branch channels in Sep'21 for services that take up max vol in branches
STP and NFTR is for requests processed through digital channels in Sep'21 for 13 services built under BOF

We are the leader in cloud adoption in the banking sector

Why cloud was vital in Axis Bank's transformation agenda

By Rajiv Bhuva | June 29, 2021



Amitabh Chaudhry, Managing Director and CEO of Axis Bank, on the bank's core transformation strategy—and the future of banking.

mint

Axis Bank chooses AWS to transform digital experience



Axis Bank will use AWS to build new digital services. mint (Photo: Mint)

moneycontrol

Axis Bank inks multi-year deal with AWS for powering digital banking services

As part of the agreement, Axis Bank will draw on the breadth and depth of AWS services to build a portfolio of new digital financial services to bring advanced banking experiences to customers, including online accounts that can be opened in under six minutes and instant digital payments.



Business Standard

Axis Bank strikes cloud computing deal with AWS for digital transformation

India's third-largest private sector bank to migrate 70% of its on-premises data centre infra in next 24 months to further reduce cost, improve agility, improve customer experience

Axis Bank to send 70% of its apps and infrastructure to the cloud

The Indian bank turns to AWS for digital banking transformation.

By Asha Barbaschow | June 30, 2021 - 01:01 GMT (06:31 IST) | Topic: Cloud

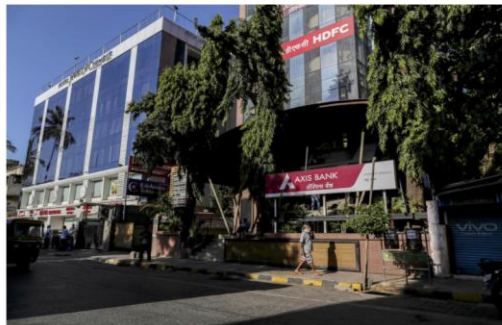

Watch: How Covid-19 made Axis Bank think digital and cloud-first

Anand J | 20 Aug, 2020



SUBSCRIBE TO NEWSLETTERS

Enter email for newsletters.



As India went into lockdown to contain the Covid-19 crisis in March, the country's third-largest private sector lender Axis Bank moved swiftly to ensure that employees have access to critical applications to maintain business continuity.

500 deployments in CI/CD mode through the 'Jenkins' pipeline

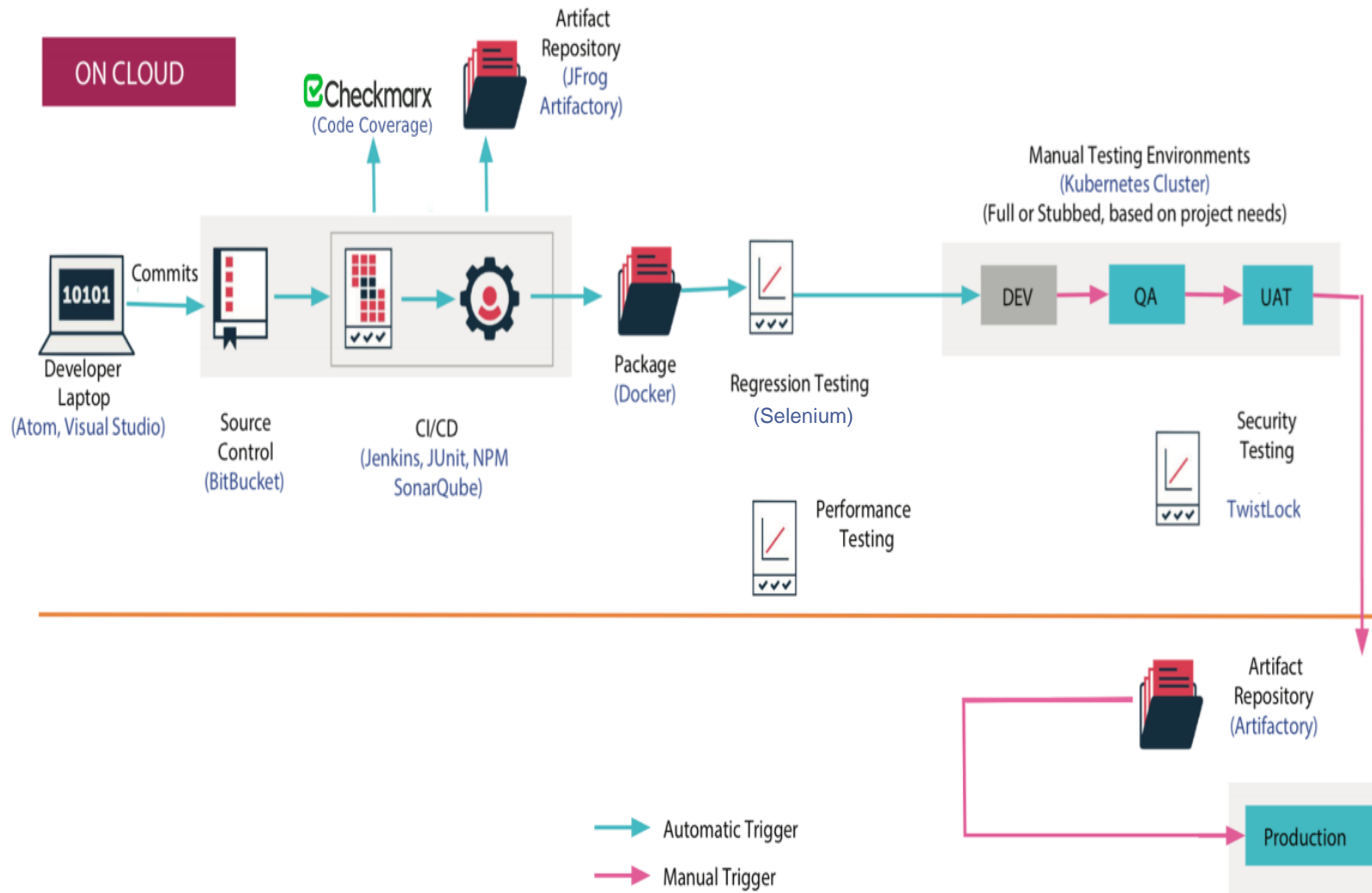

The **DevSecOps Build Farm** for Axis is capable of handling **multi cloud CI CD**

All security tools have **embedded security tolerance**

Platform supports the entire spectrum from **monolithic deployment** in traditional application servers to **cutting edge deployment in managed services Kubernetes**

Features like ChatOps, automated functional and non functional testing are in the pipeline to evolve it to a **truly touchless CI CD platform**

Resiliency at Axis being built through multiple initiatives

Built for Resiliency



Data Centre

Data Centers Expansion
DRM solution implemented
DR drill calendar for Apps



New Age Tech.

Adoption of SDN, Latest Enterprise Class Storage, HCI, Cloud, Engineered Systems, Tapeless Backup



Data

Maximum availability arch.
Always on methodology

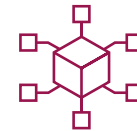

Network

N+N Arch. for critical n/w components and dynamic routing protocols



Cloud

Cloud Platform & Technologies adoption with **~50** Apps live from Cloud



Standardization

Infra Standardization covering Hardware & Software tech



Monitoring

24x7 Resiliency Operation and Network Operating Centre monitoring using NMS Tools



Assessments

Business impact analysis, data center and app resiliency audits

Continuous Technology Refresh - Year-on-year >25% Refresh towards Latest Technology Adoption

Continuous Re-skilling - Technology adoption of techniques like SRE, Technology Labs etc.

Governance - IT Strategy of the Board, Management Reviews



Key focus areas

Developing in-house tech, design and AI capabilities

The Bank is focusing on developing its in-house capabilities

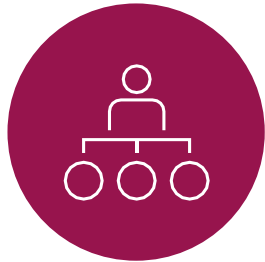

Enterprise Architecture Practice that focuses on building a **sustainable governance structure to rationalize and optimize** the application architecture



Agile Centre of Excellence (CoE) to build capabilities to deliver faster
Key roles such as **Agile Coach, Scrum Master** are being introduced across IT projects to drive adoption and leverage benefits



Customer Experience will be a **focal point** of all technology developments and enhancements and therefore, Bank has invested on experienced talent in this area
Subzero design - a collection of guidelines and components to create a unified experience for all Axis Bank customers

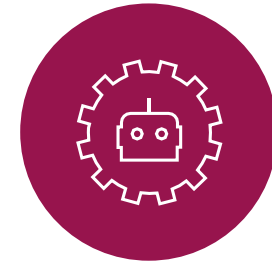

IA center of excellence (CoE) to create overall automation strategy and adoption of industry practices enabling **scaling automation** and maximize benefits within the bank and its subsidiaries

66% increase in the IT team strength in the last 2 years

Sub-zero design platform for a unified user experience

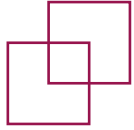

Subzero is a collection of guidelines and components shared among designers and developers in order to create a streamlined and enjoyable user experience for all Axis Bank customers.



At its centre is the pattern library which contains reusable components and foundations, from the individual atoms to the full templates and pages..



Rather than focusing on pixels, developers can focus on application logic, while designers can focus on user experience, interactions, and flows.

Subzero will help reduce design and development time by ~20%, and provide consistency across customer journeys

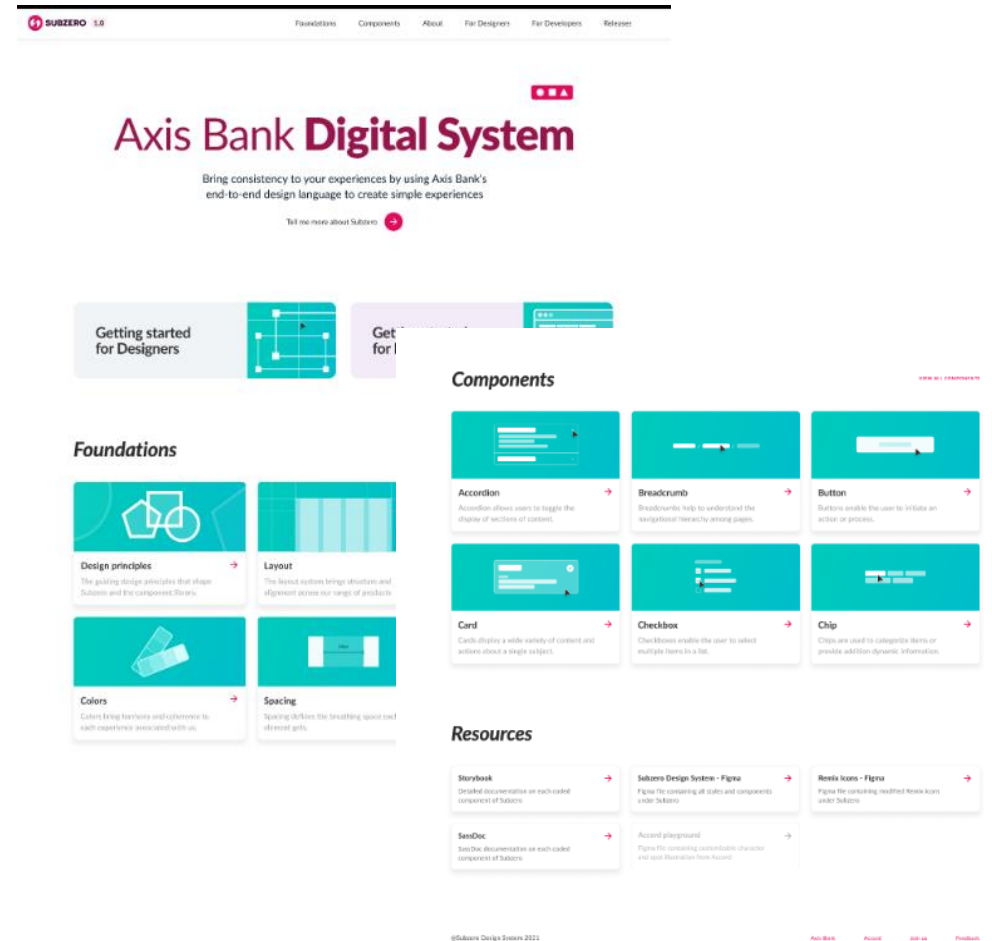

Committed to Highest Standards of Data Security and Customer Privacy (1/2)

Security by Design



Defence in depth through best in class security technology and process controls



Vulnerability and threat management across the entire tech. landscape



24 x 7 events monitoring by SOC through Next Gen SIEM, threat intelligence tools



Continuous RED Team exercises to proactively and timely vulnerability identification



Continuous transaction monitoring supplemented by real-time decline rules



Strengthening Cyber resilience program with focus on detect and respond/recover activities



Security Analytics for enhanced security threat visibility



780 / 900
Bitsight Rating¹

1. BitSight Rating = Key Risk Indicator of Over all Cyber Security. Cybersecurity ratings company based in Boston, US (2011). Approach similar to credit ratings for financial risk. BitSight Security Ratings are calculated on a scale of 250-900 with a higher rating indicating better security performance.

Committed to Highest Standards of Data Security and Customer Privacy (2/2)

Key Capabilities



In-House Cyber Breach Assessment

For safely simulating multiphase, real-world attacks, and identify gaps / vulnerabilities in Bank's environment.



24x7 Dark Web Monitoring

- a. Fraudulent / Phishing sites
- b. Artificial Intelligence based Digital Risk Monitoring for Bank's sensitive data on Internet / Dark web



Cyber Security Threat Intelligence from best-in-class commercial sources



Cloud Cyber Security Suite

Container security monitoring & vulnerability Scanning

Cloud security compliance monitoring



Cyber Security controls for DevSecOps Pipeline

Static analysis

Dynamic analysis

Real-time vulnerability monitoring and analysis

Cloud container image signing

Cloud secret keys and credential management

Our digital strategy is aligned with our GPS strategy

A

Reimagine Customer Proposition



Digital-first products embedding design thinking



End-to-end simplification of customer journeys



Banking services **integrated across partner ecosystems**



Omnichannel experience to **differentiate** customer experience & **hyper personalization**

B

Transform the Core



Ops excellence & institutionalization of data & tech enabled operating rhythm



Twin-engine approach to build digital stack and **modernize the core**



Modular, resilient technology with **cloud first** architecture



Proprietary in-house capabilities for accelerated design and go-to-market



Next gen **cyber security capabilities**

C

Build Future-ready Capabilities



Data architecture 3.0; moving beyond analytical models to **data engineering**



Integrating **alternate, unconventional data** for **risk-moderated growth**



Digital workforce for digital consumers



Creating a **cutting edge, future ready workspace 2.0**

Best in class analytics solution leveraging alternate data to implement large scale models

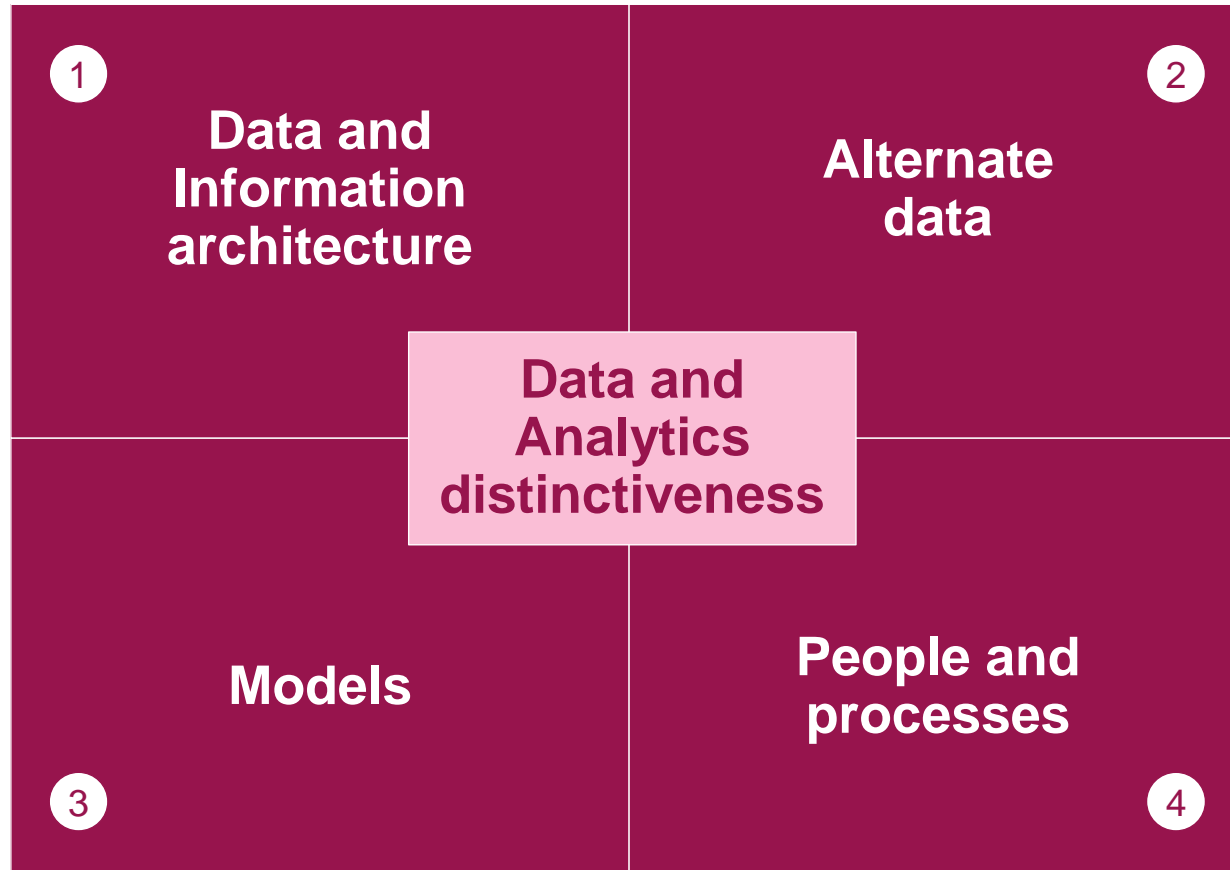

- 1 We have begun our **cloud data infrastructure** journey
- 2 We are building **alternate data platforms** to enable score-based underwriting for next 100 million+ customers
- 3 We are also implementing large number of **credit and marketing models** leveraging advanced techniques with new age data to drive better predictive and to drive sourcing
- 4 Agile team with expertise in **alternate data and risk set up**, and a robust test and learn approach to **risk framework and program building** and scale-up set up to drive the initiative

We are moving to Data Architecture 3.0

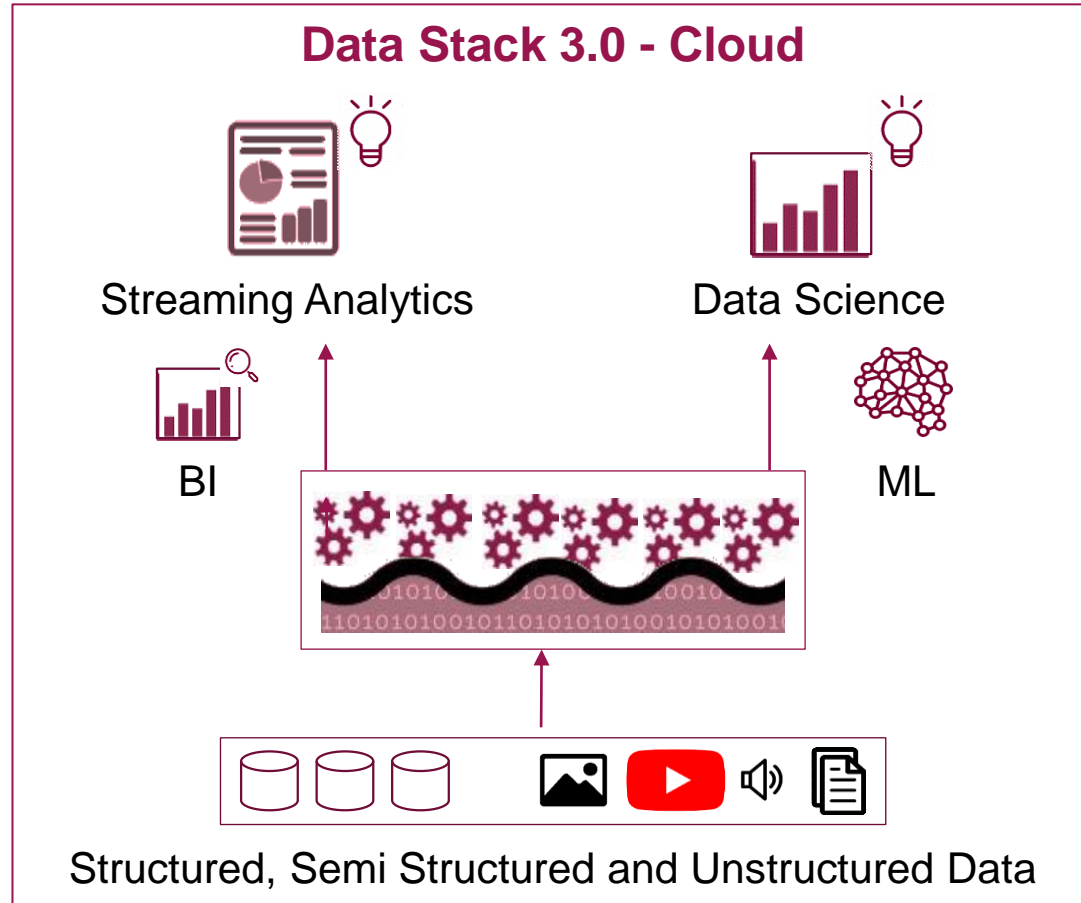

On the fly elasticity
Separation of compute from storage

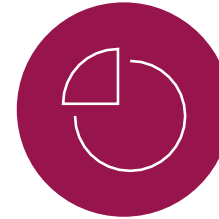

Big data clusters developed on Hadoop with **PetaByte** scale data



150+ use cases deployed across credit, fraud, marketing analytics on cloud decisioning platform

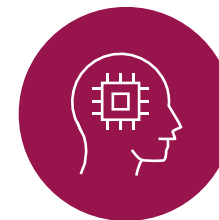

Multiple machine learning based credit models developed; **2000** attributes considered; up to **120%** lift on GINI over generic bureau models

KTB cards sourcing has started contributing significantly with good risk outcomes and activation rates

% of Business contribution

KTB (Known to Bank) base of **140 mn customers**

Built **market tested credit models** based on KTB data

Credit risk outcomes for KTB performing significantly better than expectations

Bank is currently launching **KTB based programs** – Focus is on scaling them going forward

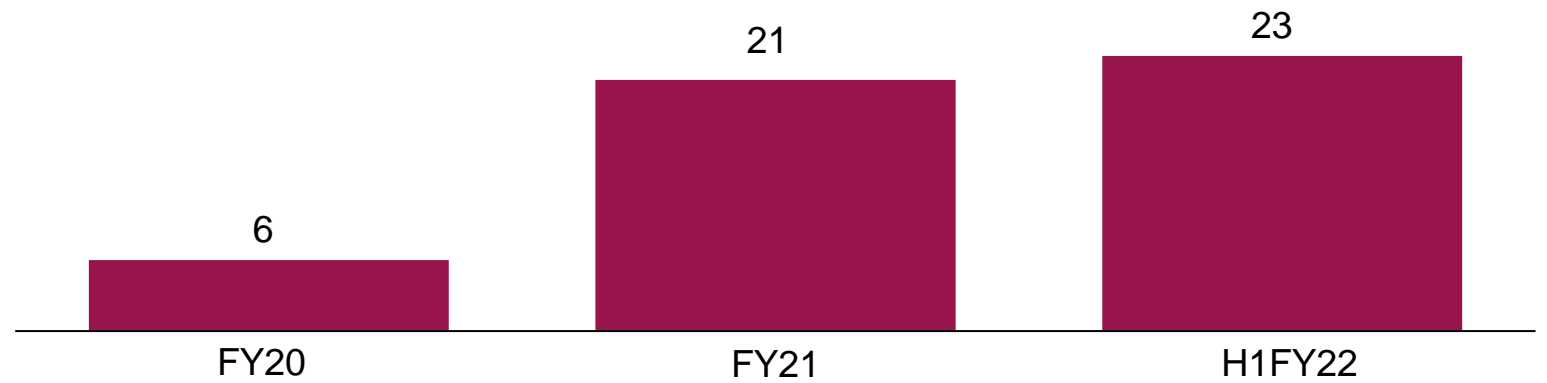

30 day activation rates (Indexed) for H1FY22 period

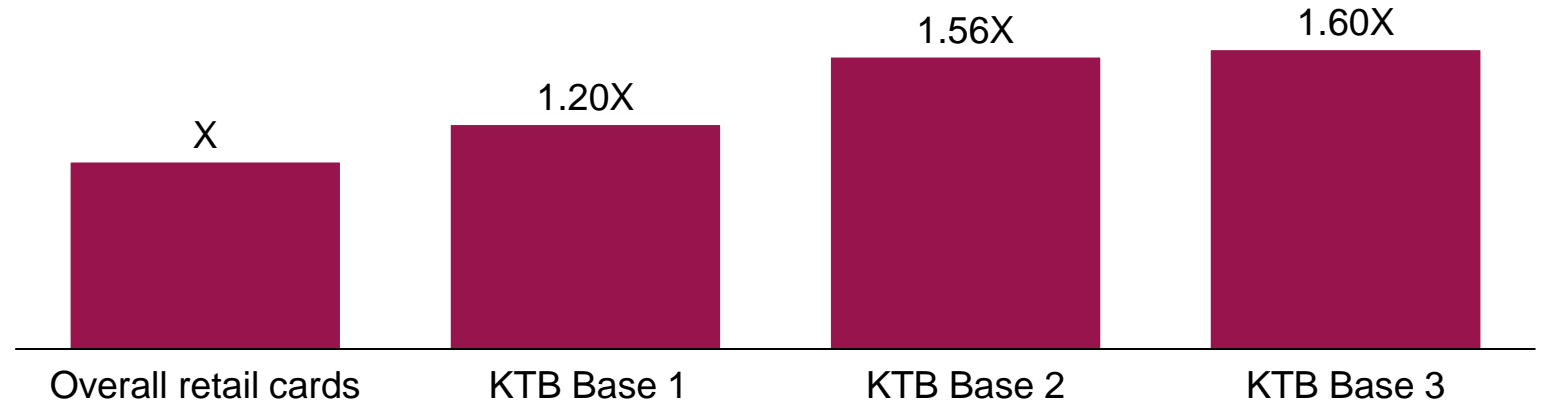

Building the right team with the right talent



~1000

...people dedicated to digital agenda

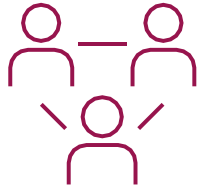

250

.. member strong in-house tech team

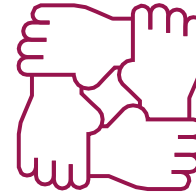

~77%

...new hires from non-banking background

- Fintech's
- E-commerce
- IT
- Consulting
- Campus
- Others

.. across roles forming full service teams

- Design
- Product managers
- Developers: Front-end, backend, full stack
- Dev-ops
- QA
- Scrum masters
- Digital marketers
- Partnerships
- Governance
- Channels

The organization is moving to more flexible ways of working...

Future of work 2.0



20% Employees in alternate formats

~2,500

full-time employees now working from anywhere; reinforcing Axis group's position as a leader in employee flexibility

~100%

Hybrid work the new normal, all employees have returned to office two days a week

Benefits

Structural reduction in costs
Better employee satisfaction
Ability to attract new talent pools

... and creating a future-ready workspace

One Axis App

App with enhanced Self-Service and access to required information through ~30 modules

Onboarding

Virtual ID, visiting card & mandatory declarations for new joinees

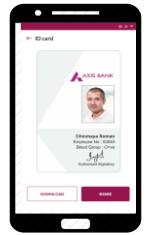

Active Transaction

One screen view of benefits, employee profile, payroll and reimbursements, leave management, staff loans, ESOPs etc.

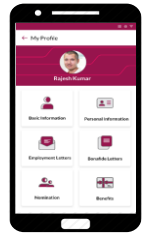

Others

COVID support – Online expert consultation, vaccination badge & reimbursement
Webcast, Axis Champions, My GPS, Contributions to social causes, Online Approval System, Tap P2P



Thank you

